

Article number: 20992D40M12

Description: E+G Threaded end-caps - GN 992-D40-M12

Measures

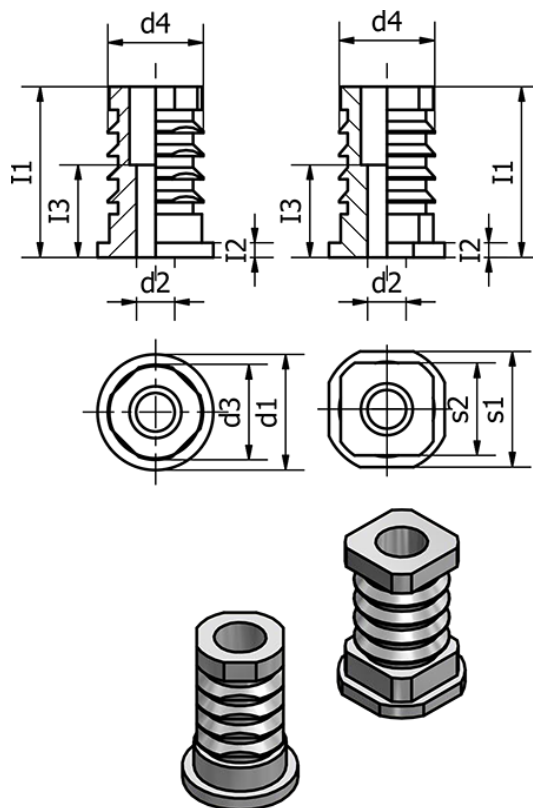

d1 = D40

d2 = 12

d3 = 34

d4 = 34.5

I1 = 41.5

I2 = 2.5

I3 = 24

s1 =

s2 =

Weight (g) = 78